



AURORA[®]

Inverters

INSTALLATION AND OPERATOR'S MANUAL

Model number: PVI-3600-OUTD-UK-F-W

Rev. 1.0

REVISION TABLE

Document Revision	Author	Date	Change Description
1.0	T. Melzl	5/1/2006	First release of the document
1.1	T.Melzl	5/3/2006	Updated Anti-Inlanding reference



SAVE THESE INSTRUCTIONS !



IMPORTANT SAFETY INSTRUCTIONS

MAGNETEK: Reproduction and disclosure, even partially, of the contents of this manual are strictly forbidden without prior authorization of Magnetek.



MAGNETEK
UNCOMMON POWER

IMPORTANT SAFETY INSTRUCTIONS

This manual contains important safety and operational instructions that must be accurately understood and followed during the installation and maintenance of the equipment.

To reduce the risk of electrical shock hazards, and to make sure the equipment is safely installed and commissioned, special safety symbols are used in this manual to highlight potential safety risks and important safety information. The symbols are:



WARNING: the paragraphs highlighted by this symbol contain processes and instructions that must be absolutely understood and followed to avoid potential danger to people.



NOTE: the paragraphs highlighted by this symbol contain processes and instructions that must be rigorously understood and followed to avoid potential damage to the equipment and negative results.

The equipment is provided with several labels, some of them with a yellow background, which are related to safety issues.

Make sure to read the labels and fully understand them before installing the equipment.

The labels utilize the following symbols:

	Equipment grounding conductor (Main grounding protective earth, PE)
	Alternate Current (Ac) value
	Direct Current (Dc) value
	Phase
	Grounding (Earth)



MAGNETEK
UNCOMMON POWER

USEFUL INFORMATION AND SAFETY STANDARD

FOREWORD

- The installation of AURORA must be performed in full compliance with national and local standards and regulations
- AURORA has no internal user serviceable parts other than fuses.
For any maintenance or repair please contact the nearest authorized repair center. Please contact your reseller if you need to know the nearest authorized repair center.
- Read and understand all the instructions contained in this manual and become familiar with the safety symbols in the relevant paragraphs before you install and commission the equipment
- The connection to the distribution grid must be done only after receiving approval from the distribution utility as required by national and state interconnection regulations, and can be done only by qualified personnel.
- Safety Brake the wind turbine to prevent any possibility of high voltages appearing at the connecting cable terminations.
- The AC disconnecting means must be opened before working on the Aurora Wind inverters.

GENERAL

During inverter operation, some parts can be powered, some not properly insulated and, in some cases, some parts can move or rotate, or some surfaces can be hot. Unauthorized removal of the necessary protections, improper use, incorrect installation or incorrect operation may lead to serious damage to people and objects.

All transport, installation and start-up, as well as maintenance operations, shall be carried out by skilled and trained personnel (all national regulations on accidents prevention shall be complied with ! !).

According to these basic safety rules, qualified and trained people have skills for the assembling, start-up and operation of the product, as well as the necessary requirements and qualifications to perform such operations.

ASSEMBLY

Devices shall be assembled and cooled according to the specifications mentioned in the corresponding documents.



In particular, during transport and handling, parts shall not be bent and/or the insulation distances shall not be changed. There should be no contact between electronic parts and connection terminals.

Electrical parts must not be mechanically damaged or destroyed (potential health risk).

ELECTRICAL CONNECTION

With the inverter powered, comply with all prevailing national regulations on accidents prevention.

Electrical connections shall be carried out in accordance with the applicable regulations, such as conductor sections, fuses, PE connection.

OPERATION

Systems equipped with inverters shall be provided with further control and protective devices in compliance with the corresponding prevailing safety rules, such as those relating to the compliance with technical equipment, accident-preventing regulations, etc. Any calibration change shall be made using the operational software. Once the inverter has been disconnected from the power grid, powered parts and electrical connections shall not be touched as some capacitors could be charged.

Comply with all corresponding marks and symbols present on each device. During operation, make sure that all covers and doors are closed.

MAINTENANCE AND SERVICE

Comply with manufacturer's recommendations.

SAVE ALL DOCUMENTS IN A SAFE PLACE !



MAGNETEK
UNCOMMON POWER

PVI-3600-OUTD-UK-F-W

This document applies to the above-mentioned inverters, only.



Fig. 1 - Product label information example

The identification plate present on the inverter includes the following data:

- 1) Manufacturer Part Number
- 2) Model Number
- 3) Serial Number
- 4) Production Week/Year

CONTENTS:

1	FOREWORD	9
1.1	WIND ENERGY	9
2	SYSTEM DESCRIPTION	9
2.1	Main Elements of a Wind System:	10
2.2	Data Transmission and Check	12
2.3	AURORA Technical Description	12
2.4	Protective Devices	14
2.4.1	Anti-Islanding	14
2.4.2	Ground Fault	14
2.4.3	Further Protective Devices	14
2.5	System Design:	15
3	INSTALLATION	15
3.1	Package Inspection	16
3.2	Package Check List	17
3.3	Choosing Installation Location	18
3.4	Wall Mounting	19
3.5	Preliminaries to Electrical Connections	22
4	START-UP	31
5	MONITORING AND DATA TRANSMISSION	32
5.1	User's Interface Mode	32
5.2	Available Data	34
5.2.1	Real time data	34
5.2.2	Internally Logged Data	34
5.3	LED Indicators	35
5.4	Messages and Error Codes	38
5.5	LCD Display	40
6	DATA CHECK AND COMMUNICATION	47
6.1	RS-485 serial link	47
6.2	Power Line Modem (PLM)	49
6.3	Display menu	51
6.4	Address Information	51
6.5	Manual address setting	51
6.6	Automatic setting	52
6.7	Verifying the paralleled input configuration.	52
6.8	Measurement Accuracy	54
7	TROUBLESHOOTING	56
8	TECHNICAL FEATURES	58
8.1	Input Values	58



8.2	Output Values	60
8.3	Grid protection characteristics	60
8.4	General characteristics	61
8.5	Power Derating	62



MAGNETEK
UNCOMMON POWER

1 FOREWORD

This document contains a technical description of the AURORA wind inverter so as to provide the installer and user all the necessary information about installation, operation and use of AURORA.

1.1 WIND ENERGY

Industrialized countries (greater energy consumers) have been experimenting with energy-saving methods and reducing pollutant levels. This may be possible through a shrewd and rational consumption of well-known resources, and also by looking for new forms of clean and in exhaustible energy.

Renewable sources of energy are fundamental to solving this problem. Under these circumstances, wind energy exploitation to generate electrical energy is becoming more and more important worldwide.

2 SYSTEM DESCRIPTION

AURORA inverter changes the wind energy into AC power which is fed to the electrical power distribution grid.

AURORA does this conversion, also known as Dc to Ac inversion, in a very efficient way, without using rotating parts but just static power electronic devices.

When used in parallel with the grid, the alternate current generated by the inverter is directly fed to the domestic distribution circuit, which in turn is also connected to the public power distribution grid.

The wind energy system can thus feed power to all the grid-connected loads, such as lighting devices, household appliances, etc.

If the energy generated by the wind energy system is not enough, the energy necessary to ensure the standard operation of the connected users is drawn from the public power distribution grid. Any excess energy produced by the inverter is exported to the grid.

According to national and local standards and regulations the produced energy can be sold to the grid or credited to the user against future consumption.



MAGNETEK
UNCOMMON POWER

2.1 Main Elements of a Wind System:

A wind system is composed of a wind turbine, a permanent magnet generator or alternator, Wind Interface Box and Aurora Wind inverter.

The output of wind turbine is converted from mechanical energy into electrical energy by the permanent magnet (PM) generator. The output of the PM generator is a variable frequency, variable voltage waveform, commonly referred to as "wild AC".

The output of the PM generator is feed into the Wind Interface Box. The Wind Interface Box provides rectification and diversion load control. The diversion load control when connected to a properly sized resistive load provides control of the turbine output in high wind, over-speed conditions and loss of grid which will cause the unloading of the wind turbine. The diversion load is not a safety brake.

The Aurora Wind inverter changes the rectified output of Wind Interface box into useable AC which is supplied to the grid at pre-determined nominal voltage and frequency. The Aurora Wind inverter is supplied with the Wind turbine manufacturer's model specific power curve. The model specific power curve is used by the Wind maximum power point tracking (MPPT) to extract the maximum amount of energy from the turbine at a given rpm.



WARNING: The DC voltage shall not exceed 600Vdc for any reason, so as to avoid damage to the equipment.



NOTE: A minimum DC input voltage value of 50Vdc is required to start-up the grid connection sequence of AURORA Wind. Once connected, AURORA will transfer to the grid the maximum power available from the string for any DC input voltage value in the range from 50Vdc to 530Vdc.



MAGNETEK
UNCOMMON POWER

The Aurora Wind Inverter is designed to accept only a single wind input. The current of this input is limited to 20 Amperes.

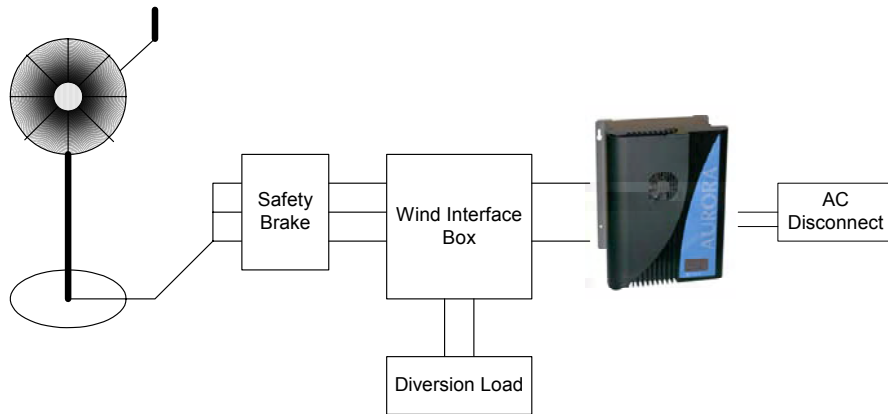

Fig.3 Simplified diagram of a Wind system



2.2 Data Transmission and Check

In case multiple inverters are used, they can be monitored remotely by using an advanced communication system based on the serial interface RS485 or on the Power Line Modem (PLM) technology. For further information, refer to the corresponding sections of this manual.

2.3 AURORA Technical Description

Figure 4 shows a block diagram of AURORA. The main blocks are the input Dc-Dc converters (called boosters) and the output inverter. Both the Dc-Dc converters and the output inverter work at high switching frequency to minimize size and weight.

This model of AURORA is transformer-less, that means that there is no galvanic isolation between input and output. This allows an increase the inverter efficiency. AURORA is equipped with all the protection needed to operate safely and to comply with existing safety regulations even without an isolation transformer.



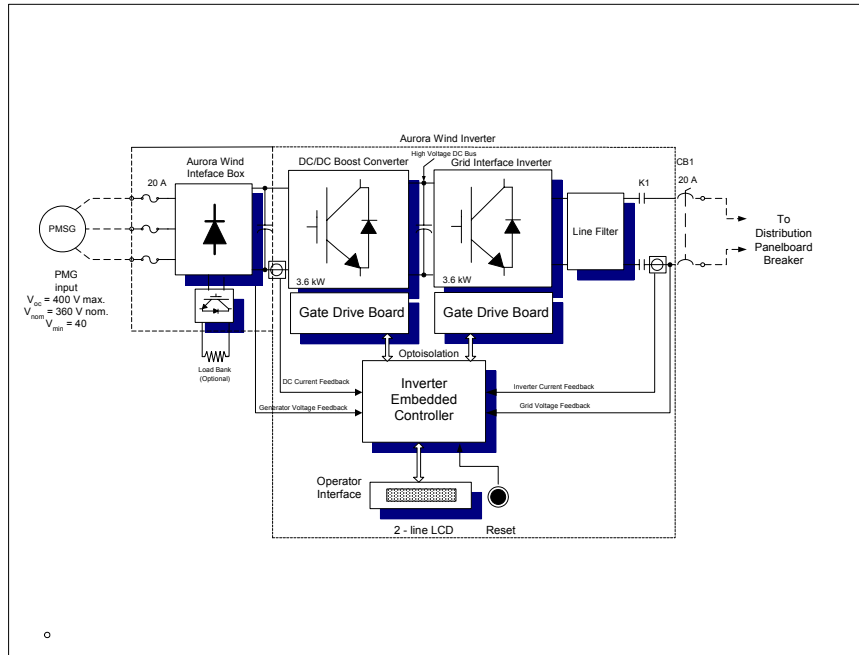

Fig.4 AURORA block diagram

The block diagram shows the model AURORA PVI-3600-OUTD-UK-F-W with its two input Dc-Dc converters. The two Dc-Dc converters are controlled in parallel by the Wind maximum power point tracker control.

Thanks to its high efficiency and large heat-sink, AURORA offers max. power operation over a wide ambient temperature range.

The inverter is digitally controlled by means of two independent Digital Signal Processors (DSP), and one microprocessor.

Two single-chip independent computers maintain control in full compliance with the electric standards relating to systems power supply and safety.

The AURORA operating system performs inter-process communication checks to ensure the entire unit operates properly.

This process ensures optimal performance levels of the whole unit, as well as a high efficiency over the input voltage operating range and load conditions, always in full compliance with the applicable directives, standards and regulations.

2.4 Protective Devices

2.4.1 Anti-Islanding

When the local power distribution grid fails due to a fault or when the equipment is shut down for maintenance operations, AURORA shall be physically disconnected under safety conditions, so as to protect the people working on the grid, in full compliance with the applicable prevailing national standards and regulations. To avoid any possible islanding operation, AURORA is provided with an automatic disconnection protective system called Anti-Islanding.

The AURORA PVI-3600-OUTD-UK-F-W model is equipped with an advanced Anti-Islanding protection certified according to the Clear Skies standard.

2.4.2 Ground Fault

The Ground fault detection identifies ground faults that are present on the DC input conductors and the AC output conductors. An advanced ground fault protection circuit continuously monitors the earth (ground) connection and shuts down AURORA in case a ground fault is detected and indicates the ground fault condition by means of a red LED on the front panel. AURORA is equipped with a (chassis) ground screw clamp, which shall be used for connection of the plant Protective Earth conductor (equipment grounding conductor). See section 3.5 (step 4/7) for detailed grounding instructions.



WARNING: Do not connect the Wind AURORA inverter to multiple wind turbine inputs. The AURORA inverter is designed for connection to a single wind turbine only.



NOTE: For detailed information on AURORA disconnection and on malfunctioning causes, refer to the corresponding sections.

2.4.3 Further Protective Devices

AURORA is equipped with additional protections to guarantee safe operation under all circumstances. The protections include:

- Continuous monitoring of the grid voltage to ensure the frequency and voltage values are within the proper operational limits;



MAGNETEK
UNCOMMON POWER

- Control of the internal temperatures to automatically drive the speed of the external cooling fan. This will allow the inverter to deliver the maximum output power for ambient temperatures up +40 ° C .

The AURORA is designed for safe and reliable operation. This is made possible by the use of redundant control circuits.

2.5 System Design:

The overall system design of a wind system is critical to successful operation and maximizing energy production.

Step 1:

The first step is determining the wind resource at a location is a site survey and possible wind monitoring.

Step 2:

The second step is purchasing a pre-designed wind system that includes the Aurora Wind inverter with a turbine specific power curve.

A wind turbine model specific power curve is pre-programmed into the Aurora Wind Inverter. The wind power curve is used by the Aurora Wind Maximum power point tracking algorithm to product the maximum amount of available energy.

Step 3:

The third step a proper installation of the entire wind energy system.

3 INSTALLATION



WARNING: The electrical installation of AURORA must be made in accordance with the electrical standards prescribed by the local regulations and the National electrical standards.



MAGNETEK
UNCOMMON POWER



WARNING: The connection of AURORA to the electrical distribution grid must be performed only after receiving authorization from the utility that operates the grid.

3.1 Package Inspection



NOTE: The distributor presented your AURORA WIND Inverter to the delivering carrier securely packed and in perfect condition. Upon acceptance of the package from the distributor the delivering carrier assumes responsibility for its safe arrival to you. Regardless of the attention paid by carrier in handling it, sometimes the package and its contents might be damaged.

Please, carry out the following checks:

- Examine the shipping box for any visible damage: punctures, dents or any other signs of possible internal damage;
- Describe any damage or shortage on the receiving documents and have the carrier sign their full name;
- Open the shipping box and inspect the contents for internal damage. While unpacking, be careful not to discard any equipment, parts or manuals. If any damage is detected, call the delivering carrier to determine the appropriate action. They may require an inspection. Save all shipping material for the inspector to see!
- If the inspection reveals damage to the inverter call your supplier, or authorized distributor. They will determine if the equipment should be returned for repair. They will also provide instructions on how to get the equipment repaired;
- It is your responsibility to file a claim with the delivery carrier. Failure to properly file a claim for shipping damages may void warranty service for any physical damages later reported for repair;
- Save the AURORA original packaging, as it will have to be used in case the equipment has to be shipped out for repairs, or the responsible inspector requires it.



3.2 Package Check List

Description	Quantity (No.)
Wind Inverter	1
Bag with 4 screws, 4 blocks and 1 Tap wrench Torx TX20	1
One mounting reference drawing	1
One copy of this manual	1
One certificate of warranty	1
CD-Rom with communication software	1



3.3 Choosing Installation Location

The location for the installation of AURORA should be selected in accordance to the following recommendations:

- AURORA should be placed at a suitable height from ground to allow easy reading of the front display and the status LEDs.
- Leave enough room around the unit to allow easy installation and maintenance.
- Choose a location sheltered from sun radiation and able to provide some ventilation. Avoid locations where air cannot freely circulate around the unit, or directly exposed to the sun.
- The mounting location should also allow space for the Wind Interface Box and the Diversion load.
- Minimum clearance requirements on the sides easily access the side cover and to obtain the best performance of the unit are as per the following figure:

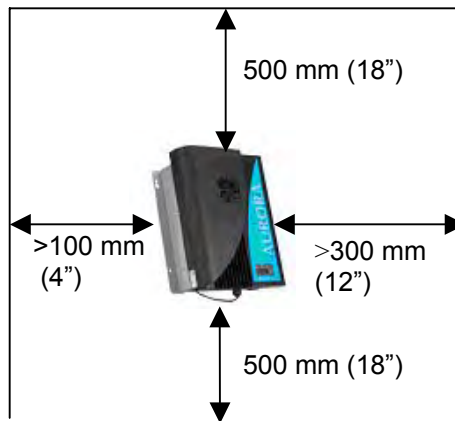

Fig.5 Minimum clearance requirements



3.4 Wall Mounting

AURORA should be mounted in a vertical position as shown in figure 7.



NOTE: AURORA ratings are based on a vertical mounting position. Although it is possible to mount AURORA in a tilted position, the thermal performance in that case may be de-rated. In any case avoid mounting AURORA with the front plate rotated, always make sure that the fins of the front heat-sink are vertical.

To facilitate wall mounting a reference drawing is provided in the package (Fig.6). Use the drawing to locate the holes on the wall. A set of standard expansion stainless steel screws is included in the package for use in mounting the AURORA to a masonry wall. In case of different materials make sure to select the proper mounting hardware. Always use stainless steel mounting hardware, if the supplied hardware is not used.

The clearance hole in the mount bracket is 8 mm.

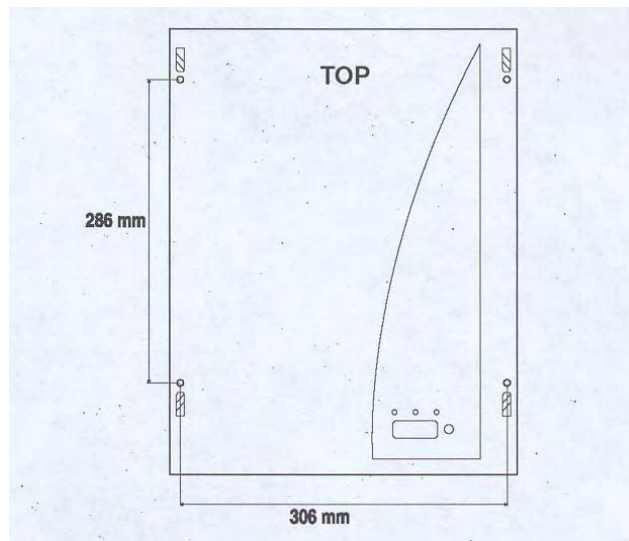

Fig.6 Wall mounting diagram



Install the expansion screws in the wall so that the head of the screws is about 4mm from the wall surface. Then hang AURORA on the wall by fitting the screw heads in the mounting slots as shown in Fig.7, and secure the screws.



Fig.7 AURORA wall mounting

It is possible to mount AURORA in a tilted position. In that case the thermal dissipation will not be optimized and the cooling fan may start at lower ambient temperatures than the pre-set intervention threshold.



NOTE: In case of installation of several units, MAGNETEK recommends not to install them in parallel, superimposed, rows. In fact the heat generated by the bottom rows will get the ambient temperature of the upper inverters to increase. At ambient temperatures



MAGNETEK
UNCOMMON POWER

higher than + 40 °C an output power de-rating may occur on the top units.



Fig.8 Recommended multi Aurora mounting

It is recommended that the unit be placed out of direct sunlight.



WARNING: During operation, inverter surface can reach very high temperatures.
DO NOT touch inverter surface to prevent the risk of burns.

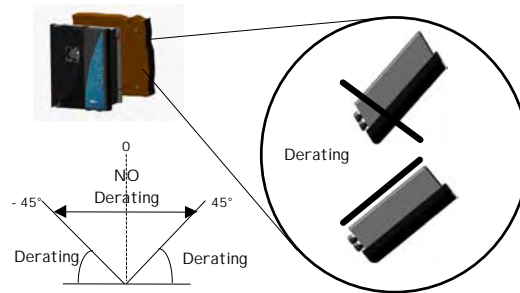

Fig.9 Inverter tilted mounting



3.5 Preliminaries to Electrical Connections



WARNING: The electrical connections can be done only after AURORA is firmly mounted to the wall.



WARNING: The connection of AURORA to the electrical distribution grid must be performed only by skilled operators and after having received authorization from the utility that operates the grid.



WARNING: For further details on each single step, carefully read and follow the “step-by-step” instructions of this section (and sub-sections), as well as all safety warnings. Any operation non-complying with the instructions below can lead to operator/installer hazards and to equipment damage.



WARNING: Always respect the nominal ratings of voltage and current defined in chapter 9 (Technical Characteristics) when designing your system. In particular, regarding the wind system:

- Maximum Dc input voltage for the MPPT input circuit: 600Vdc in any condition.
- Maximum Dc input current for the MPPT input circuit: 20A dc in any condition.



WARNING: Make sure that your installation design is in compliance with National electrical wiring methods and local std regulations, if more stringent.



WARNING: The wind turbine must be braked to a zero energy state during the installation procedure. The protection must be removed once the installation has been verified and is ready for safe operation.



WARNING: RS-485 cable must be certified wiring and must be additionally protected by means of a non-metallic tubing.



NOTE: The inverter shall be connected ONLY to a dedicated branch circuit. According to the typical assembly diagram (see Fig.10). An AC disconnecting mean with over-current protection must be used to connect



AURORA to the grid. Recommended ratings for the Ac over-current protection device is maximum 20A, 240V.

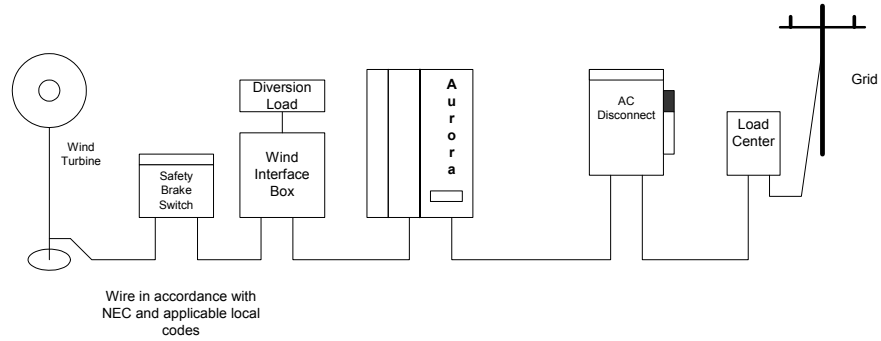

Fig. 10 General wiring diagram



CAUTION: To reduce the risk of fire, connect only to a circuit provided with 20A maximum branch circuit overcurrent protection.



WARNING: Always apply the safety brake on the wind turbine before opening the AC disconnecting means.



MAGNETEK
UNCOMMON POWER



WARNING: All power wires connecting to AURORA inverter must have a section of at least 14 AWG (2.5mm²) and must be able to operate at temperature of at least 90 °C. All wiring must be sized in accordance with the National electrical standards and applicable local codes. The wire size may need to be increased due to temperature, wire length and conduit fill factors. The wiring should be rated for wet location, UV sunlight-resistant and outdoor location. Consult with a qualified electrical designer when determining system wiring.

Minimum MPPT input connection Dc wire size, 12 AWG, 20 Amps.

Minimum Ac wire size, 12AWG, 16 Amps.

Maximum MPPT input wire and AC wire size is 10 AWG strand wire

The AURORA must be installed using watertight wiring methods. This requires the use of UL listed watertight components and locknuts with the applicable wiring method. On the bottom of the unit there are four 29mm diameter holes (Trade size 3/4") covered with cap Elektrozubehör, type H 400 P (model designation K 426 21 P) or equivalent UL listed watertight cap. Un-used holes shall be left sealed by the caps. Fig.11 shows an example of hole assignment.



WARNING: It is the installer responsibility to make the conduit connection watertight, by using the properly listed components and locknuts, and by applying the correct tightening torque.



Fig.11: Position of the holes on the bottom side



MAGNETEK
UNCOMMON POWER



 **WARNING:** Use listed watertight conduit connectors to maintain the enclosure rating of the AURORA inverter.
To access the wiring terminal strip inside of the AURORA inverter remove the side panel as shown in Fig.12. Removing the panel allows you to access the screw terminal blocks and the conduit access holes.



Fig.12: Removing the side panel

 **WARNING:** To avoid the risk of electric shock from energy stored in capacitors. Wait 5 minutes after disconnecting both Ac and Dc connections before opening the side panel.

The conduit and the wire lengths depend on the distance between the unit and Ac disconnect and the Wind Interface Box. The wires must be inserted in the conduits and routed to the terminal blocks. Pay careful attention in bending the cables properly. The insulation at the end of the cable should be stripped back $\frac{1}{2}$ " (14mm). The maximum wire size that the terminal will accept is 10AWG.



WARNING: When making the electrical connections follow this exact procedure to avoid exposure to dangerous voltages. Each step of the procedure is explained in the following paragraphs.
To disconnect AURORA always open the breaker (AC and DC) prior to do any further operation.



MAGNETEK
UNCOMMON POWER

Step 1/7: Open the Ac disconnect switch or circuit breaker and lockout the Ac disconnecting means.

Step 2/7: Open the Dc disconnect switch and lockout the Dc disconnecting means.

Step 3/7: Verify there is no voltage on the connection terminals.

Step 4/7: Connect AURORA to the Main Ground (Protective Earth)

The input and output circuits are isolated from the enclosure.
The plant must have a Protective Earth (Equipment main ground) connection as required by the National Electric Code ANSI/FNPA 70 for proper equipment ground conductor sizing. The Protective Earth cable must be connected to the AURORA chassis ground connection as shown in Fig.14 using the screw provided. Tighten the screw to a torque of 0.6 Nm (5.3 in-lbs).

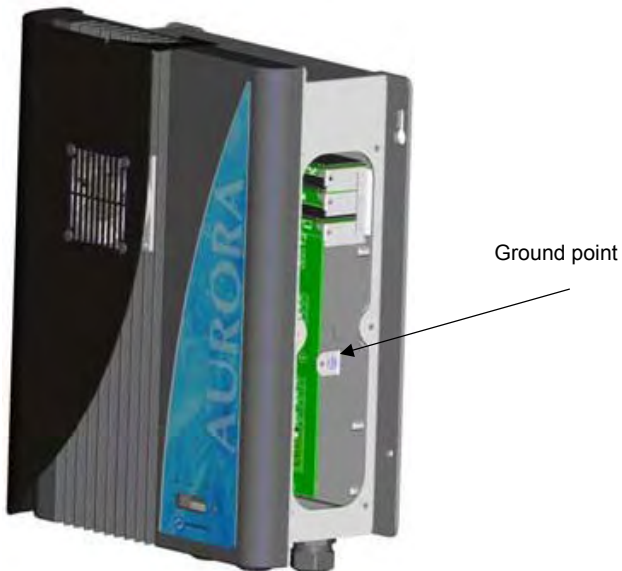

Fig.13: Location of Main Ground PE Screw

Step 5/7: Connect AURORA to the Ac disconnect switch or circuit breaker



WARNING: Use proper, low impedance cables to connect AURORA to the Ac disconnect or circuit breaker, and between the disconnecting means to the grid. To ensure proper operation the impedance seen at the Ac output terminals of AURORA must be below 1ohm.

- 1) Mount the conduit between AURORA and the Ac disconnect
- 2) Connect the conduit to the AURORA by using suitable watertight conduit connectors
- 3) Insert three cables labeled L1 (phase ONE of the split-phase system), L2 (phase two of the split-phase system) and GND (Grid Ground) in the conduit and run them to the terminal blocks of AURORA
- 4) Connect the cable L1 to the terminal block labeled L1
- 5) Connect the cable L2 to the terminal block labeled L2
- 6) Connect the cable GND to the AURORA chassis ground connection labeled \perp
- 7) Make the proper connections to the Ac disconnect. The L1 cable must be connected to Line side terminal 1, L2 must be connected to Line side terminal 2 and GND must be connected to ground terminal.
- 8) Verify that all connections have been executed properly and all the screws are properly tightened (torque of 0.6Nm/5.3in-lbs).



NOTE: In case your system has an additional kW-hour meter installed between the Ac disconnect and AURORA, please apply the Ac connection procedure to the terminals of the meter.

Step 6/7: Connect AURORA to the Dc disconnect switches

Your wind system will have one MPPT input circuit when connecting to AURORA Wind inverter.



NOTE: AURORA Wind has two independent Dc input sections, each of them capable of handling a maximum power of 2000W and a maximum current of 10A. You have to parallel the input terminal sections as shown in Fig.14. You can use the extra screw terminal block to wire a (14 AWG) jumper between the two sections.



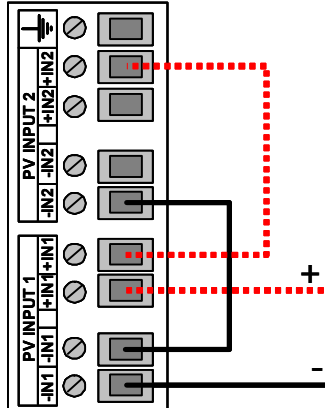

Fig.14: Wind Input with the two input sections paralleled



NOTE: Paralleling the two input sections, the input current rating becomes equivalent to 20A (24A short circuit). In the parallel mode configuration the maximum input power limit is equivalent to the max output power plus losses. It can be rated to 3800W.



WARNING: Take special care to ensure the Wind MPPT voltage polarity corresponds to the symbols “+” and “-” labeled on the contacts of the Wind Interface Box. Before connecting AURORA with the Wind Interface Box, Magnetek recommends checking, using a proper gauge, that the polarity value and the allowable voltage value between positive and negative contacts are correct.

Wind MPPT connection: Follow this procedure for connecting the Wind Interface to the Aurora Wind Inverter.

- 1) Install the suitable wire method between AURORA Wind inverter and Wind Interface Box.



- 2) Install suitable watertight connectors to the AURORA enclosure
- 3) Terminate the wires labeled + and – in the same input section terminal blocks of AURORA Input 1.
- 4) Connect the cable + to the terminal block labeled +
- 5) Connect the cable – to the terminal block labeled –
- 6) Tighten the screw to a torque of 0.6Nm (5.3 in-lbs.)
- 7) Make the proper connections of the cables to the Wind Interface Box. The + wire must be connected to the positive terminal of the Wind Interface box, the – wire must be connected to the negative terminal of the Wind interface box.
- 8) Verify that all connections have been executed properly and all the screws are tight.

Step 7/7: Close the side panel



WARNING: Tighten side panel screws with a torque of 1.5 Nm (13.2 in-lbs) to ensure watertight sealing.



MAGNETEK
UNCOMMON POWER

4 START-UP



NOTE: do not lay any object on AURORA during operation.



WARNING: do not touch the heat sink during operation, some parts could be very hot and cause serious burns.

To turn on AURORA by turning ON the AC disconnecting means after allowing the wind turbine to turn.

- 1) To turn on the AURORA WIND Inverter the Wind Turbine via the Wind Interface Box must supply at least 50 VDC at the AURORA WIND Inverter Input Terminals.
- 2) When the control power threshold voltage is met the green power LED on the inverter will start to blink.
- 3) Switch the Ac disconnect to the ON position.
- 4) AURORA will start operating and the green LED labeled Power on the front panels will start blinking while the grid is checked to make sure that voltage, impedance and frequency parameters are within operating range requirements. The check can last several minutes depending on the conditions of the grid. During the check the LCD display will show a sequence of three screens, indicating:
 - Remaining time for next connection.
 - Grid voltage value and status (in or out of range)
 - Grid frequency value and status (in or out of range)
- 5) If the grid check is successfully and the input power has remained above the 50 V control power threshold the inverter will connect to the grid.
- 6) Then the AURORA will export to the grid and the green Power LED will be continuously lit (provided there is enough wind input power to feed power to the grid).
- 7) If the grid check is not successful the unit repeats the check over and over again until acceptable grid parameters are found. During this procedure the green power LED keeps blinking. Measure the grid voltage and frequency and then verify the grid configuration of the unit.



MAGNETEK
UNCOMMON POWER

5 MONITORING AND DATA TRANSMISSION

5.1 User's Interface Mode



WARNING: RS-485 cable must be UL/CSA certified wiring and must be additionally protected by means of a non-metallic tubing.

The AURORA inverter usually works automatically and is maintenance-free. When the wind speed is not high enough to provide power for export to the grid AURORA disconnects automatically, and enters the stand-by mode, waiting to start working again. The operational cycle is automatically restored as soon as the wind speed is high enough.

AURORA inverter can provide operational data in the following ways:

- LED indicators
- Operational data on the LCD display
- Data transmission on a dedicated serial RS-485 line. The data can be collected by a PC or data logger equipped with a suitable RS-485 port or with the optional RS-485/RS-232 AURORA serial interface converter, or by AURORA Easy Control data logger*.
- Data transmission on the Ac grid by means of a dedicated Power Line Modem (PLM). The data can be collected by a PC equipped with the optional PLM adapter., or by AURORA Easy Control data logger*.

*Check on availability with Factory.

Please check web site www.alternative-energies.com for updated information



MAGNETEK
UNCOMMON POWER

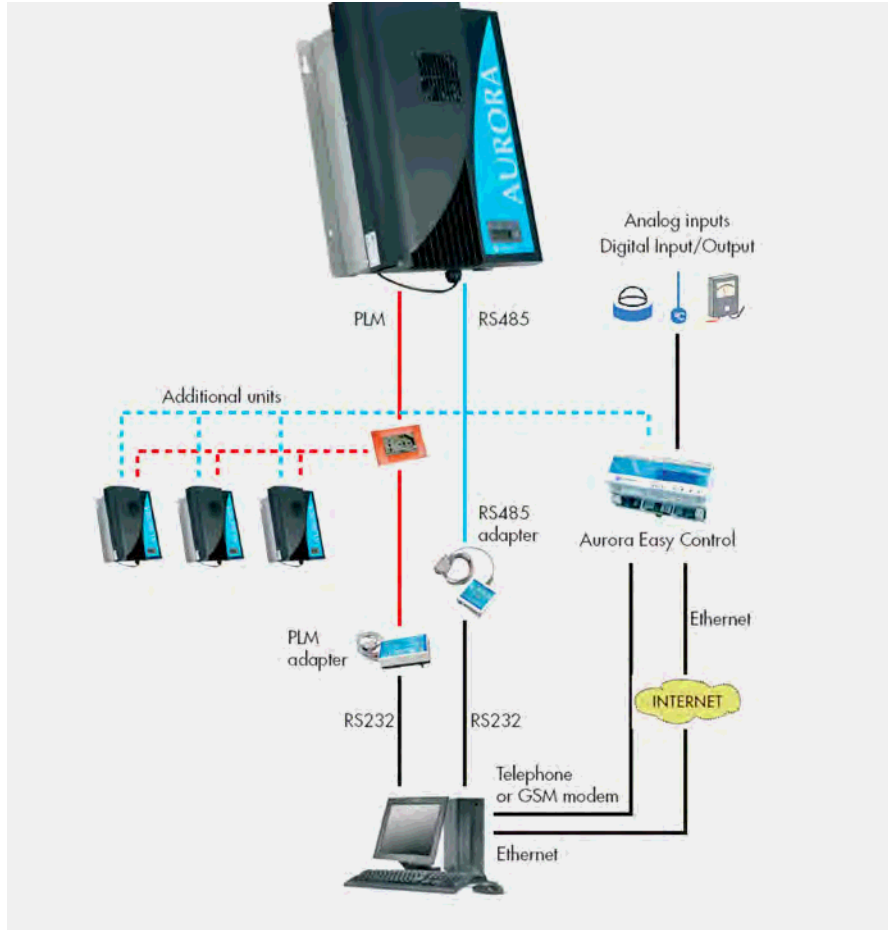

Fig. 15 Data Transmission Options

5.2 Available Data

AURORA provides two sets of data that are accessed using AURORA interface software.

5.2.1 Real time data

The real time operating data can be transmitted on request over the communication lines and is not recorded internally by the AURORA inverter. The AURORA interface software can be used to retrieve and store data on a PC computer. The following data is available:

- Grid voltage
- Grid current
- Grid frequency
- Power transferred to the grid
- Voltage of IN1
- Current of IN1
- Voltage of IN2
- Current of IN2
- Heatsink temperature
- Serial Number Part Number
- Manufacturing week
- Firmware revision code
- Energy produced so far in the day
- Leakage Current

5.2.2 Internally Logged Data

AURORA stores internally the following data:

- Lifetime counter of grid connection time
- Lifetime counter of energy transferred to the grid
- Energy transferred to the grid every 10 seconds for the last 8640 periods of 10 seconds (which on average cover more than 2 days logged data)
- Partial counter of grid connection time (the counter start time can be reset by using the AURORA software)
- Partial counter of energy (uses the same start time of the partial time counter)
- Last 100 fault conditions with error code and time stamp
- Last 100 variations to the grid connection parameters with parameter code, new value.



All data are available for transmission via the RS-485 link or PLM. In addition, the first two data of the list are displayed on the LCD. The AURORA Communicator software shall be used in order to download the internally stored data.

5.3 LED Indicators

On the front panel of the AURORA inverter there are three LEDs, which give status indications:

1. A green LED labeled Power
2. A yellow LED labeled FAULT
3. A red LED labeled GFI (ground fault)

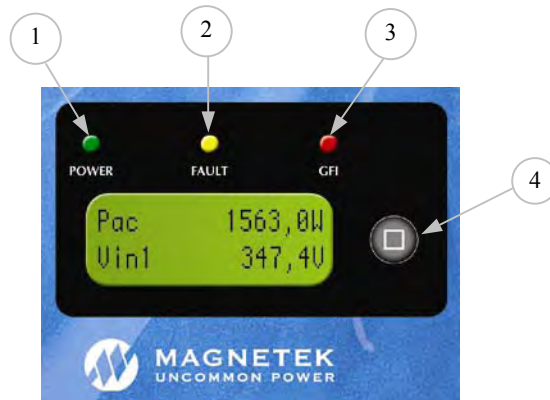

Fig.16 LED's location

KEY:

- LED on
- ▣ LED blinking
- ⊠ LED off
- Any of the above conditions



	LEDs Status	Operational Status	Remarks
1	Power (Green): ☒ Fault (Yellow): ☒ GFI (Red): ☒	AURORA self-disconnection during no or low wind conditions.	Input voltage below 50 Vdc on the MPPT input
2	Power (Green): ◐ Fault (Yellow): ☒ GFI (Red): ☒	AURORA initialization, settings loading and waiting for grid check	Input voltage above 50 Vdc for the MPPT input . It is a transition status while operating conditions are checked.
3	Power (Green): ■ Fault (Yellow): ☒ GFI (Red): ☒	AURORA is exporting to grid	Standard machine operation (search of max. power point or constant voltage).
4	Power (Green): □ Fault (Yellow): □ GFI (Red): ■	System insulation device faulty	Ground leakage found
5	Power (Green): ☒ Fault (Yellow): ■ GFI (Red): ☒	Malfunction – fault!!!	The Fault can be inside or outside the unit. See the alarm appearing on the LCD.
6	Power (Green): ☒ Fault (Yellow): ◐ GFI (Red): ☒	Installation phase: AURORA is disconnected from grid.	During installation, it refers to set-up of the address for RS-485 communication.



NOTE: All inverter statuses signaled by the corresponding LED coming on or blinking, are also identified on AURORA LCD by a message relating to the operation being carried out or to the defect/fault found (see following sub-sections).



- G** **1) Sleep Mode**
Y AURORA is in the disconnection phase; this happens whenever
R the input power is too low to export power to the feed grid and
power the inverter control system as well.
- G** **2) AURORA Initialization and Grid Check**
Y The unit is in the initialization phase: energy supply for the
R inverter control system is high enough. AURORA is also
checking that starting conditions – such as input voltage, starting
time, etc. - necessary for the initialization process, are satisfied.
Grid check is then started.
- G** **3) AURORA Under Production**
Y Once all electronic and safety self-tests are over, the unit starts the
R exporting process.
As stated above, during this phase AURORA carries out an
automatic search and analysis of the wind turbine power curve
max power point tracking (MPPT).
- G** **4) Ground Insulation**
Y The inverter signals a ground fault.
R This can be due to an insulation defect in the wind input
connection.
➤ Insulation Defect
An insulation fault condition has been detected in the input
wiring from the Wind Interface box or a corresponding
connection is conductive with the grounded potential.



WARNING: Trying to remove the fault by yourself is extremely dangerous. The instructions below have to be followed very carefully. In case you are not experienced or skilled enough to work safely on the unit, contact a specialized technician.

What to do after an insulation defect has been found

Whenever the red LED comes on, press the special multifunction push-button next to the LCD side to reset it. If this fault can be reset, the AURORA will continue working. If the fault cannot be



reset, there could be a water seepage due to condensation that is causing a ground fault or there is some other insulation breakdown. Have the system inspected by qualified personnel. If the signal cannot be reset, insulate AURORA on both Dc and Ac sides so as to reach a safe condition; then contact an authorized center for repairing the fault.

- G** **5) Malfunction-Fault Signal**
Y Every time AURORA check system detects an operative malfunction or fault, the yellow LED comes on and a message showing the type of problem found appears on the LCD.
R
- G** **6) RS-485 Address Setting Signal**
Y During installation, the yellow LED will flash until the address is confirmed. For further information about setting the address, refer to chapter 6.3.
R

5.4 Messages and Error Codes

The system status is identified through message or error signals appearing on the LCD.

The tables below summarize the two types of signals that can be displayed.

MESSAGES identify the AURORA actual status; so they do not relate to faults and nothing has to be done. The message will disappear as soon as standard conditions are restored.

ERRORS identify a possible fault of the equipment or of the connected parts. The signal will disappear as soon as the causes are removed, except for the ground insulation fault. Usually, when an error signal appears, an action is needed. This action will be managed as much as possible by AURORA or, in case this is not possible, AURORA will supply all the necessary information to assist the person fixing the fault on the equipment or system.



Message	Warning Type	Error Type	Description
Wind Low	W001	//	Input Voltage under threshold
Input OC	//	E001	Input overcurrent
Wind Low	W002	//	Wind Energy low
Input OV	//	E002	Input Overvoltage
Internal Error	//	E003	SW error
Bulk OV	//	E004	Bulk overvoltage
Internal Error	//	E005	Communication Error
Out OC	//	E006	Output overcurrent
Internal Error	//	E007	IGBT saturation
Internal Error	//	E008	Bulk undervoltage
Internal Error	//	E009	Internal Error
Grid Fail	W003	//	Grid Fail
Internal Error	//	E010	Bulk Low
Internal Error	//	E011	Ramp Fail
DC/DC Fail	//	E012	DcDc error revealed by inverter
Wrong Mode	//	E013	Wrong Input setting (Single instead of dual)
Over Temperature	//	E014	Overtemperature
Capacitors Fault	//	E015	Bulk Capacitor Fail
Inverter Fail	//	E016	Inverter fail revealed by DcDc
Internal Error	//	E017	Start Timeout
Ground Fault	//	E018	I leak fail
Internal Error	//	E019	leak Sensor fail
Internal Error	//	E020	Self test error 1
Internal Error	//	E021	Self test error 2
Internal Error	//	E022	Self test error 4
Internal Error	//	E023	Dc-Injection Error
Grid OV	W004	//	Grid overvoltage
Grid UV	W005	//	Grid undervoltage
Grid OF	W006	//	Grid overfrequency
Grid UF	W007	//	Grid underfrequency
Z Grid HI	W008	//	Z Grid out of range
Internal Error	//	E024	Internal Error
-----	//	E025	Riso low (log only)
Internal Error	//	E026	VRef Error
Internal Error	//	E027	VGrid Measures error
Internal Error	//	E028	FGrid Measures error
Internal Error	//	E029	ZGrid Measures error
Internal Error	//	E030	ILeak Measures error
Internal Error	//	E031	Wrong V Measure
Internal Error	//	E032	Wrong I Measure
Internal Error	//	E033	Undertemperature



5.5 LCD Display

The 2-line LCD display is located on the front panel and shows:

- ✓ the status of the inverter and statistical data;
- ✓ service messages for the operator;
- ✓ messages of faults or damages found.

Data are shown cyclically, the screens change every 5 seconds. On the right of the display there is a button that when pressed freezes the screen. Pushing the button again unfreezes the screen. When AURORA is turned on the display shows the following screen for about 10 seconds:

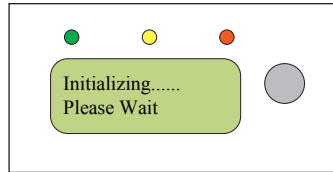

Afterwards it begins to check the grid. While checking the grid the display shows the three following screens cyclically:

- ✓ This screen shows how many seconds are left before a new grid connection attempt will start.

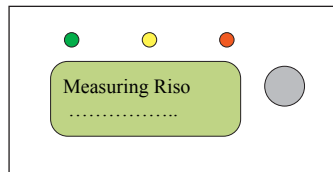

- ✓ This screen shows the grid voltage and the related status (in range or out of range).

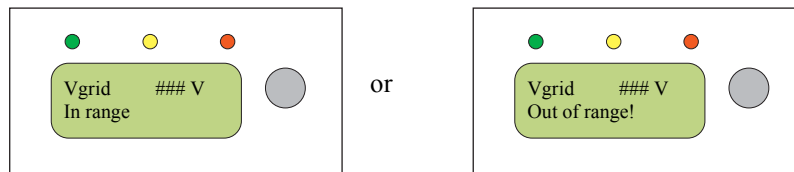

- ✓ This screen shows the grid frequency and the related status (in range or out of range, see section 9 for further details)

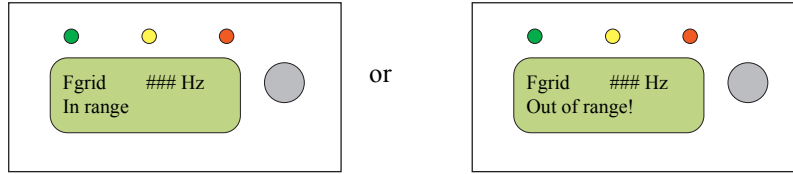

After AURORA is connected to the grid the display starts showing cyclically the following information screens, each for 5 seconds:

- ✓ First screen: Type and Part Number

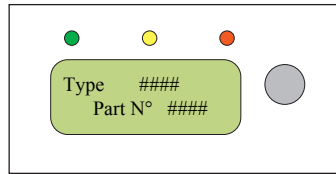

- ✓ Second screen: Serial Number and Firmware release number

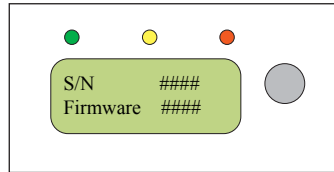

- ✓ Third screen: Measuring Resistance isolation and Leakage Isolation

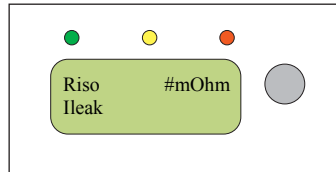

- ✓ Fourth screen: Output power and Voltage Input

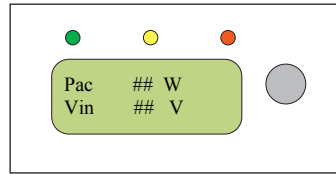

- ✓ Fifth screen: Total energy exported to the grid and total operating time (that is time during which the unit was active). Both data are measured since the unit was first operated.

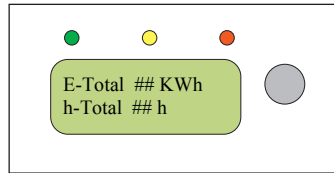

- ✓ Sixth screen: Time during which the unit exported energy to the grid, and number of times that unit connected to the grid.

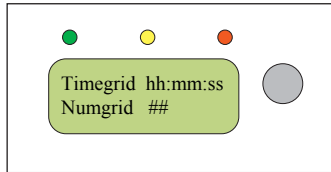

- ✓ Seventh screen: Daily energy and mode of operation of the inverter

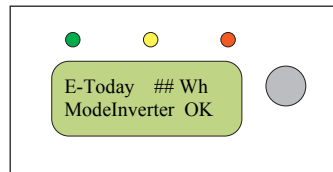

In case the inverter is not working properly the Fault or Ground Fault LEDs will turn on as described in paragraph 5.3, and the following three screens scroll on the LCD remaining on for 5 seconds. They contain important information that should be communicated to service personnel and will show cyclically on the LCD, each for 5 seconds:

- ✓ This screen shows the code of the error found, for further information refer to chapter 5.4.

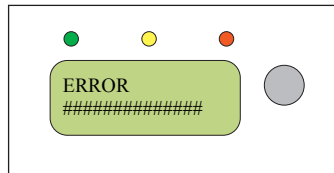

- ✓ These screens show the serial number and the firmware release number

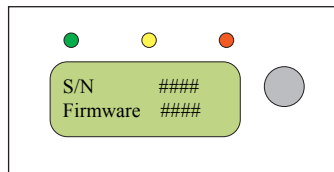
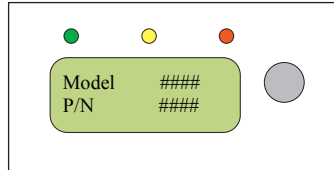

The sequence of the screens is summarized in the following figure:

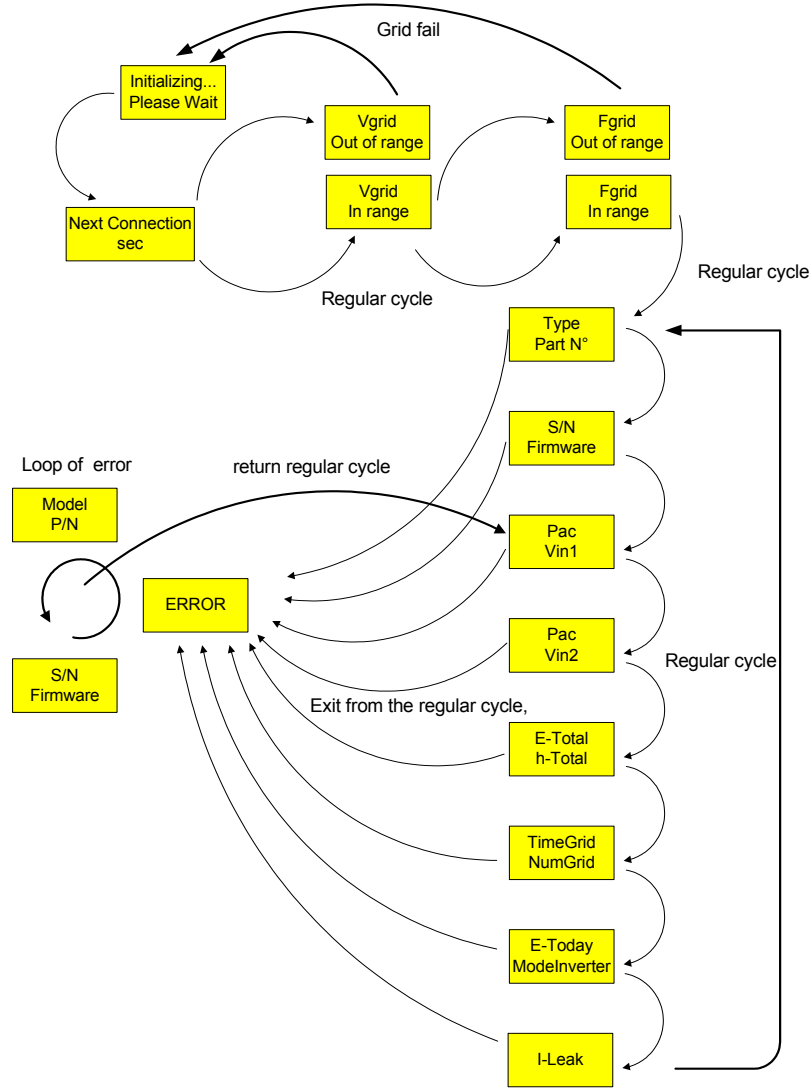

The values that can be displayed on the previous screens are summarized in the table below:

Data	Description
Vin1	Input voltage from Wind Interface Box, IN1 terminals
Vin2	Input voltage from Wind Interface Box IN2
Pac	Output Ac power
E-Total	Total energy transferred to the grid since the unit was first operated
E-Today	Total energy exported to the grid today
h-Total	Total time since the unit was first operated
Type	Type of AURORA
S/N	Serial Number
Part N°	Part Number
Firmware	Firmware release number
TimeGrid	Time during which the unit exported energy to the grid
NumGrid	Number of connections to the grid
Leakage	Leakage current



6 DATA CHECK AND COMMUNICATION

6.1 RS-485 serial link

The RS-485 link uses two wires for signals plus a third wire for signal grounding, which is different from the equipment grounding of the unit. The wires must be run in a watertight conduit through the bottom of the unit as explained in paragraph 3.5 after removing the watertight cap and installing a suitable watertight conduit connector. The wires are then run to the RS-485 screw terminal blocks and connected as shown in Fig.18:

- Signal wires must be connected to +T/R and -T/R terminals
- Grounding wire must be connected to the RTN terminal

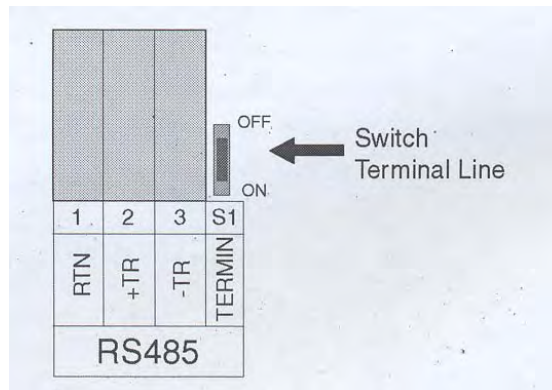

Fig.17: The RS-485 serial link terminal blocks



WARNING: RS-485 cable must be UL/CSA certified wiring and must be additionally protected by means of a non-metallic tubing.

The single AURORA has a default address is two (2) and the S1 dip switch is in the OFF position (pushed away from the side access panel). The RS-485 address does not have to be configured for the single AURORA inverter.

Up to 31 AURORA inverters can be connected on a the same RS-485 line. The maximum recommend RS-485 cable length is 1300 yards (1200 m).

In case multiple inverters are daisy-chained to the same RS-485 line, then the last unit must be identified by changing the position of the dip-switch shown in Fig.18



MAGNETEK
UNCOMMON POWER

from OFF to ON. The default position of the switch is OFF. Also, each unit must have a different address. See par. 6.3 to change the addresses.

In order for the RS485 communication line to perform the best, Magnetek recommends to connect its PVI-RS232485 adapter before the first unit of the daisy-chain (see fig. 19 for details)

Equivalent devices may also be used for the same purpose, but they have not been tested therefore Magnetek cannot grant the right functionalities.

Please also note that ordinary commercial adapters may need additional impedance termination. Aurora PVI-RS232485 adapter DOES NOT.

The following diagram shows how to connect multiple units on the same RS-485 bus.

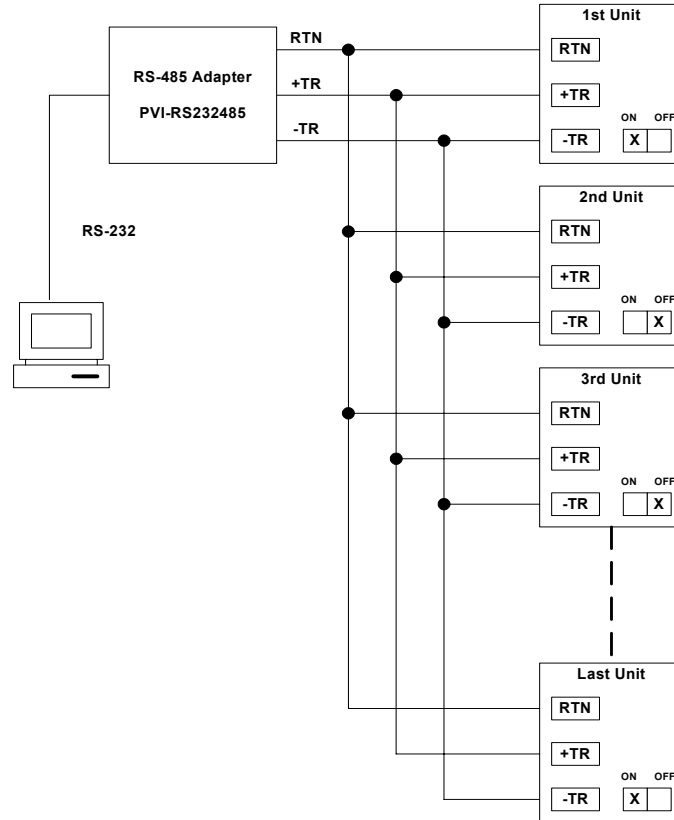

Fig.18 Multiple units connection

6.2 Power Line Modem (PLM)

A PLM modem card is an available option card for the Aurora. To collect the data transmitted over the PLM link two options are available:

- Use the AURORA Easy Control data logger, model number PVI-AEC (*Check on availability in 2007).
- Use a PLM/RS232 interface converter such as model number PVI-PLMREC-UK to connect to a PC,

In either case no additional physical connections between the inverter and the receiver are needed, as the communication uses the power lines.

In case of installations in buildings wired with three-phase systems please make sure that the AURORA inverter and the receiving equipment are both on the same phase.

The nominal transmission range is 300yards (about 300m). However, the range may be limited in case of high electromagnetic interference of the power lines. In case of extremely noisy power lines we recommend using a separate set of wires dedicated to the PLM communication, or to use the RS-485 serial link.

The maximum transmission rate of the PLM is 2400 bps.

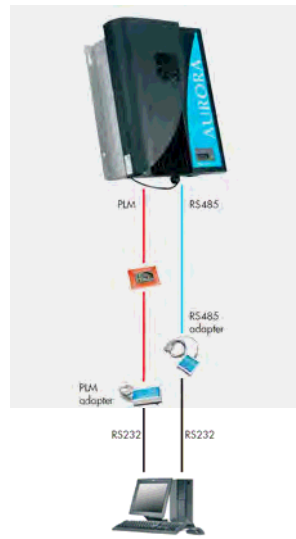



Fig.19: Data transmission to a PC



 **NOTE:** the maximum number of inverters that can be connected via PLM is 63. **NOTE:** It is not possible to have more than one receiving device such as AURORA Easy Control data logger or AURORA PLM/RS232 interface box connected to the same power line.



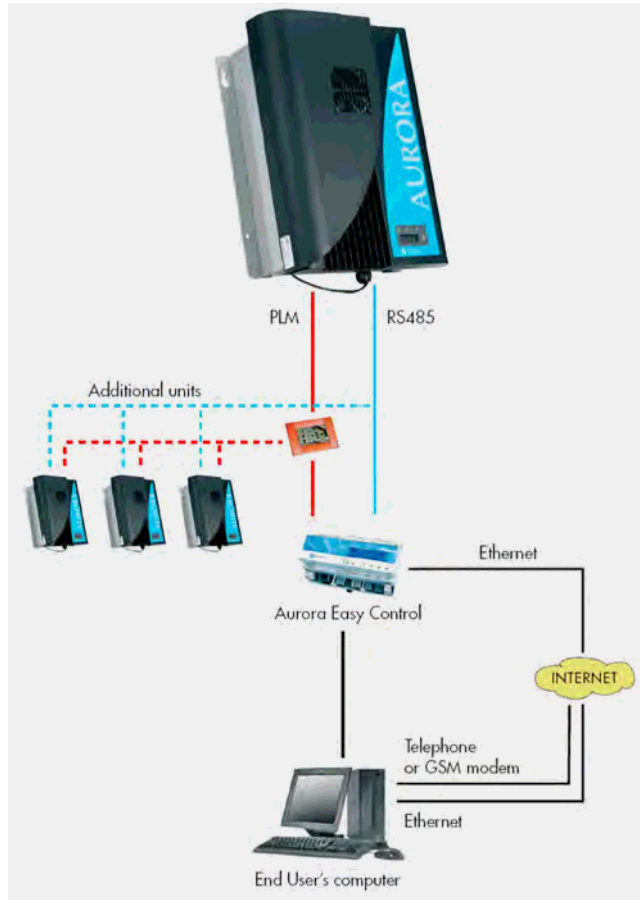

Fig.20: Data transmission to AURORA Easy Control



6.3 Display menu

When using PLM or the RS-485 serial link communication each unit must have a unique address. The default address of each unit is 2. When connecting multiple units on the same serial or PLM link a new address needs to be assigned to each unit to avoid communication errors.

6.4 Address Information

Addresses 0 is reserved for the host computers; addresses 1 is reserved for the automatic addressing mode.

The RS-485 serial link uses addresses 2 thru 33.

The PLM link uses addresses 2 thru 63.

6.5 Manual address setting

Use the following procedure to set the new address:

- 1) Press the key on the side of the LCD display button for at least 5 seconds.
- 2) AURORA disconnects from the grid, the yellow LED begins to blink and the display shows:

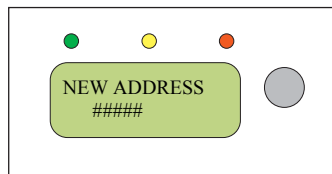

- 3) The first address is 2. Press the key as many times as needed to select the address between 2 and 63. After the number 63 there is the AUTO address. Continuing with the Key press, the address starts back from 2. In order to scroll the address number press the key for a short while (less than 5 sec.).



WARNING: The user must NOT select the address AUTO. The automatic setting of addresses through this key is a feature used on multiple wind turbine installations by factory authorized personnel using special software.



MAGNETEK
UNCOMMON POWER



4) Confirm the choice by pressing once more the key for at least 5 seconds.



NOTE: When using RS-485 link there can be no more than 31 inverters connected on the same link. Although you are free to choose any address between 2 and 63 it is recommended that you use addresses between 2 and 33 for the RS-485 serial link.



NOTE: When using RS-485 link, in case one or more inverters are later added to the system, please remember to switch back to the OFF position the dip-switch of the former last inverter of the system.

6.6 Automatic setting

The key AUTO activates the channel to select the addresses. Only Factory authorized personnel are able to perform this procedure.

6.7 Verifying the paralleled input configuration.

The inverter is configured at the factory for parallel inputs. The selected configuration can be verified through the display.

1) Once defined the inverter address, per the procedure described in § 6.5 and 6.6, press the key on the right of the display for longer than 5 sec. in order to proceed the next screen.



MAGNETEK
UNCOMMON POWER

2) Verify that the inverter is set in mode Parallel:

- SET IN MODE PARALLEL

A short touch of the key allows to scroll the two options.

In order to confirm the selection, press for longer than 5 sec. the same key.

Press it for a shorter time to come back to the previous display.

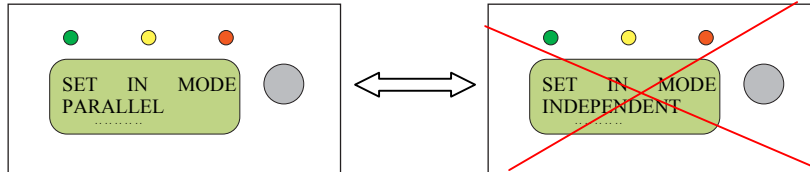

3) The "SET BAUD RATE" text and the relevant default speed (which is 19200) will be shown on the display.

4) In order to confirm the BAUD RATE at 19200, is requested to press the key for longer than 5 sec.,

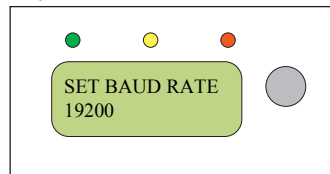

5) the other options can be visualized if pressing the key for less than 5 sec. This way the different available BAUD RATES will be shown.

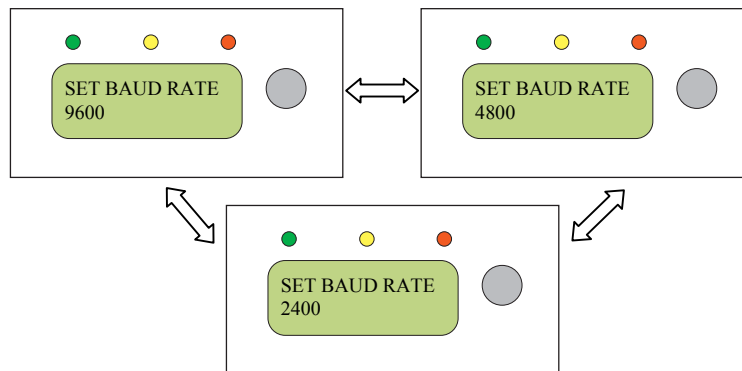

6) Press the key for longer than 5 sec. to confirm the chosen BAUD RATE shown on the display.
Press it for a shorter time to come back to the previous display.

NOTE: Generally the standard speed to be chosen is 19200 Baud. Only in presence of particularly long or noisy lines a lower speed is recommended.

6.8 Measurement Accuracy

All measurement device have errors.

For each reading the following table shows:

- Description and Measurement Unit
- Resolution and Accuracy

Data	Description	Unit
Vpv1	Voltage of IN1	Vdc
Vpv2	Voltage of IN2	Vdc
Ipv1	Current of IN1	Adc
Ipv2	Current of IN2	Adc
Pac	Output Ac power	W
E-Total	Total energy	Wh
E-Today	Daily energy	Wh
h-Total	Total time	hh:mm:ss
TimeGrid	Total time energy exported to the grid	hh:mm:ss



Data	Resolution		Accuracy
	Display	Measurement	
Vin1	1V	600mV	2%
Vin2	1V	600mV	2%
Iin1	0.1A	15mA	2%
Iin2	0.1A	15mA	2%
Pac	1W	-	2%
E-Total	1Wh	-	4%
E-Today	1Wh	-	4%
h-Total	1s	-	-
TimeGrid	1s	-	-



7 TROUBLESHOOTING

AURORA inverters comply with standards set for grid-tied operation, safety and electromagnetic compatibility.

Before being delivered by Magnetek, the product has been successfully subjected to several tests to check: operation, protective devices, performance and durability.

All these tests, together with the system ensuring Magnetek quality, guarantee AURORA optimal operation.

In case of any possible malfunction of the wind energy system, solve problems as follows:

- ✓ Working under safe conditions, as stated in chapter 3.5, check that connections between AURORA, the Wind Interface box, Wind turbine and the power distribution grid have been made correctly.
- ✓ Carefully observe which LED is blinking and read the signal appearing on the display; then, following the instructions given in chapters 5.3 and 5.4, try to identify the type of fault found.

If the malfunction cannot be identified by following these instructions, contact the Wind Turbine manufacturer or the installer (see following page).



Before contacting the service center, keep the following information handy:

INFO AURORA



NOTE: Information to be found directly on LCD

- ✓ AURORA model?
 - ✓ Serial number?
 - ✓ Week of production?
 - ✓ LED flashing?
 - ✓ Light blinking or steady?
 - ✓ Signal displayed?
-
- ✓ Observed wind speed during the malfunction.
 - ✓ There is a minimum wind speed that is needed in order to product enough energy to supply the inverter controls.
 - ✓ Short description of Malfunction ?
 - ✓ Can the malfunction be reproduced?
 - ✓ If so, how?
 - ✓ Does malfunction appear cyclically?
 - ✓ If so, how frequently?
 - ✓ Is malfunction present from installation?
 - ✓ If so, has it worsened?
 - ✓ Description of the wind speed conditions when the malfunction appeared.



MAGNETEK
UNCOMMON POWER

8 TECHNICAL FEATURES

8.1 Input Values



WARNING: The Wind turbine maximum output voltage must be less than 600Vdc in under any condition.



NOTE: The inverter has a linear power derating related to the input voltage, starting from 530 Vdc (100% output power) to 580 Vdc (0% output power)



MAGNETEK
UNCOMMON POWER

Description	Value PVI-3600-OUTD-UK-F-W
Nominal input voltage	360Vdc
Minimum input voltage to connect to the grid	50Vdc
“Absolute Maximum Rating” for input voltage	600Vdc
Input voltage, MPPT operating range	50Vdc to 530Vdc
Input voltage, MPPT range at full power	200Vdc to 530Vdc
Max. operating input current (Wind MPPT Input)	20A _{dc}
Max. input power (Wind MPPT Input)	3800 W
DC Ground fault protection	Ground fault detection and shut off of utility-interactive inverter
MPPT configuration	Single Wind MPPT , Power Curve is specific to the Wind Turbine model

As stated above, AURORA Wind performs MPPT on the programmed Wind turbine power curve and constantly researches the max. input Dc power point. This process is called **MPPT** (Maximum Power Point Tracking).



NOTE: If the input current supplied by the Wind Interface Box connected to the inverter is above the max. value and the input voltage is within the allowed range, the inverter is not damaged.



8.2 Output Values

Description	Value PVI-3600-OUTD-UK-F-W
Nominal output power	3600 W
Grid voltage, nominal operating values	230Vac
Grid voltage, operating ranges	207 to 264Vac
Grid frequency, maximum range	47 to 63 Hz
Grid frequency, nominal	50 Hz
Grid frequency, operating range	47 to 50.5 Hz
Nominal output current	16 Arms
Output over current protection	20 Arms

8.3 Grid protection characteristics

Anti-Island Grid protection	Loss of Mains protection ,according to the applicable portions of G83/1
-----------------------------	---



8.4 General characteristics

Description	Value PVI-3600-OUTD-UK-F-W
Maximum efficiency	96%
Internal consumption during stand-by	< 8 W
Internal consumption during night time	< 0,30 W
Operating ambient temperature	-25°C to +60°C (-13°F to 140°F)
Enclosure type	Nema 4X
Relative Humidity	0 – 100 % condensing
Audible Noise	< 40dBA
Size (height x width x depth):	420 x 310 x 144 mm
Weight	12.5 kg



8.5 Power Derating

To ensure inverter safe operation under any temperature and electrical condition, the unit will automatically derate the power to be delivered to the grid.

Power derating can occur on one of the two following occasions:

Power Derating due to Ambient Temperature

Under certain operating conditions, AURORA automatically regulates the power to ensure that the components are always run well-within their operating temperature limits. Several environmental factors can influence the operating temperature of the unit, such as ambient air temperature, airflow, exposure to sun radiation, input voltage and power, orientation of the heatsink fins, etc.

AURORA supplies the max output power for ambient temperatures $\leq 40^{\circ}\text{C}$, provided it is not exposed to sun radiation or other direct heat sources which may affect the internal thermal behavior.

Power Derating due to Input Voltage

The graph shows the automatic derating of delivered power when input voltage values are too high or too low.

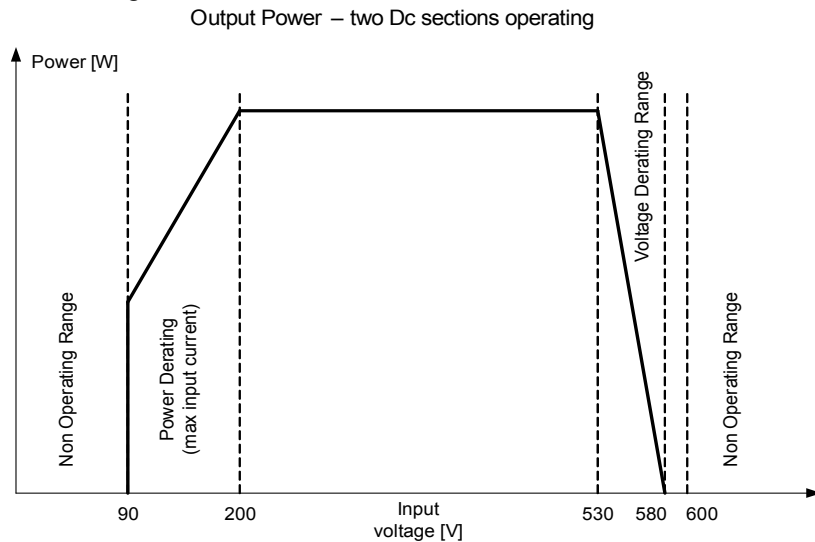

MAGNETEK
UNCOMMON POWER

The above cases, originating a power derating, can also occur at the same time, but the power derating will always correspond to the lowest value read.



MAGNETEK
UNCOMMON POWER